

LOC	DIST	REVISIONS			
P	LTR	DESCRIPTION	DATE	DWN	APVD
E	B	A1	REVISED PER ECO-11-005150	29MAR2011	RK HMR

FOR FURTHER INFORMATION SEE DATA SHEET FOR  
CBT SERIES-CARBON COMPOSITION RESISTORS

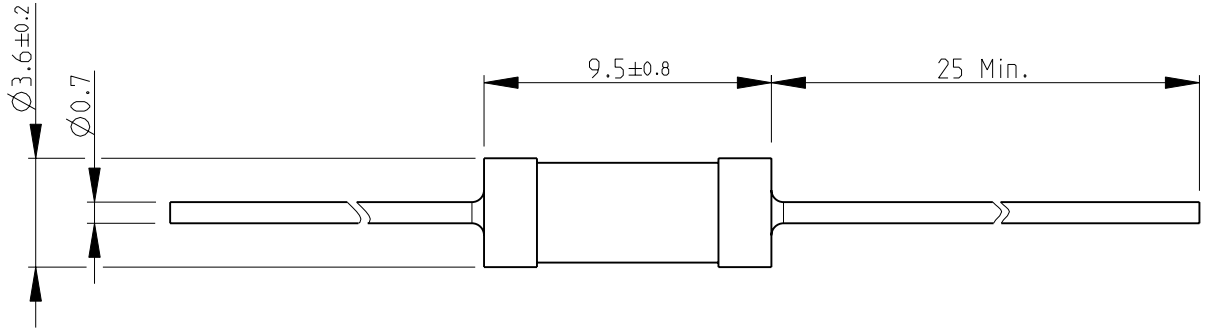

RoHS Compliant

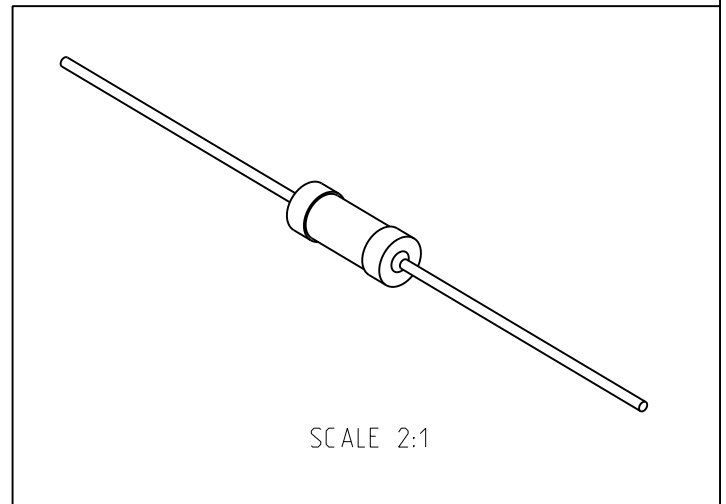

SCALE 2:1

2008

RELEASED FOR PUBLICATION

THIS DRAWING IS UNPUBLISHED.

ALL RIGHTS RESERVED.

BY -

© COPYRIGHT 2008

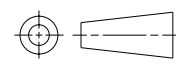

DIMENSIONS: mm	DWN SUBHASH.M	18-Sep-08	MATERIAL	-	FINISH	-
	CHK PRAKASH.S	18-Sep-08	 TE Connectivity			
TOLERANCES UNLESS OTHERWISE SPECIFIED:	APVD STEPHEN.P	18-Sep-08				
	0 PLC $\pm 0.2$	PRODUCT SPEC	NAME CARBON COMPOSITION RESISTORS SERIES CBT50			
1 PLC $\pm 0.1$	-					
2 PLC $\pm$	APPLICATION SPEC	SIZE CAGE CODE DRAWING NO RESTRICTED TO A 4 00779 C-1625876 -				
3 PLC $\pm$	-					
4 PLC $\pm$	WEIGHT	-	SCALE 4:1 SHEET 1 OF 1 REV A1			
ANGLES $\pm 5^\circ$	-					
		CUSTOMER DRAWING				